

SHOREBLOCK® PM MAT ASSEMBLY DETAIL
N.T.S.

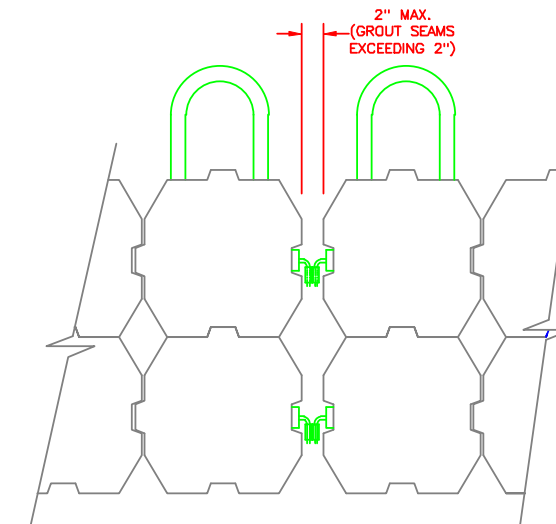

TYPICAL CONNECTION OF TWO MATS

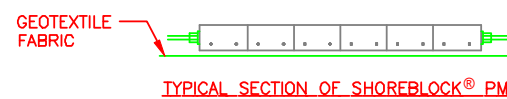
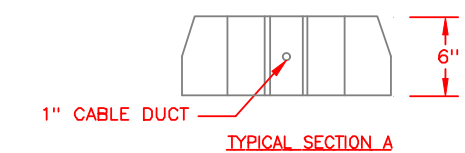
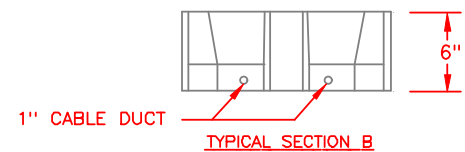
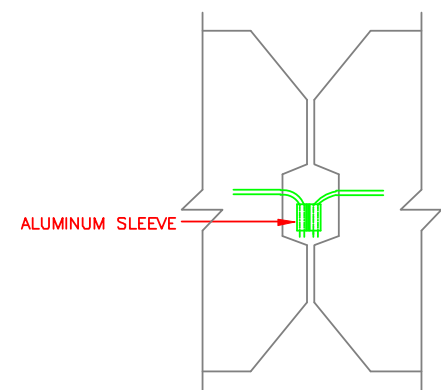
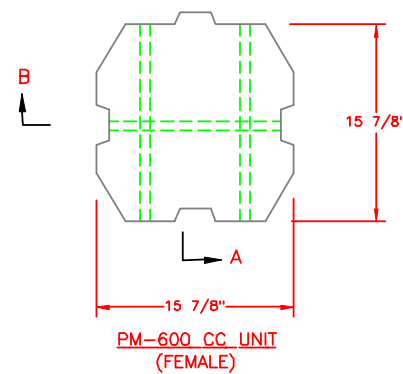
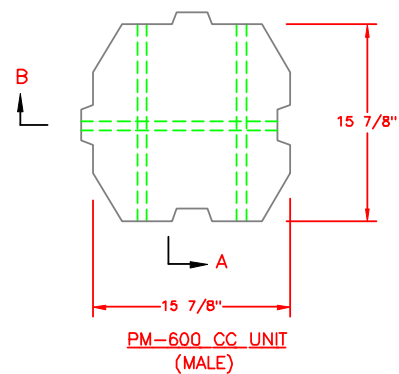

TYPICAL SECTION OF CONNECTOR
N.T.S.

TECHNICAL SPECIFICATIONS

- 1) SHOREBLOCK® PM UNITS ARE MANUFACTURED IN ACCORDANCE WITH ASTM C90 AND C140 AND THE FOLLOWING CRITERIA:
 - A) CONCRETE UNIT WEIGHT 130 - 150 LBS/CF
 - B) MINIMUM COMPRESSIVE STRENGTH - 4,000 PSI.
 - C) MAXIMUM ABSORPTION - 5 %
 - D) DIMENSIONAL TOLERANCE ± 1/8"
- 2) GALVANIZED OR POLYESTER CABLING

NOTE:

FEMALE BLOCK ARE USED ON THE OUTSIDE OF THE MATS TO ALLOW CRIMPING.

UNIT	WEIGHT LBS.	COVERAGE (lbs/sq.ft)	OPEN AREA
PM-600 CC	101 - 108	58 - 62	7%

ASSEMBLY SPECIFICATIONS

- 1) SHOREBLOCK® PM UNITS ARE SHOP ASSEMBLED IN A CABLED MATTERESS AS SHOWN ABOVE.
- 2) SHOREBLOCK® PM MATS ARE PLACED BY THE CONTRACTOR IN THE FIELD ON PREPARED SLOPES PER THE CONTRACT DRAWINGS.

SHORETEC® L.L.C.

510 O'NEAL LANE
Baton Rouge, Louisiana 70819
(225) 408-1444 - Phone
(225) 408-1445 - Fax
www.shorettec.com

Client:

Title:

SHORETEC® PM PIPELINE MAT SERIES
PM-600 CLOSED CELL

No.	Date	Revision	By

Scale:
N.T.S.

Drawn By:
A. CASE

File Name:

Project No:

Drawing No:
25

DISCLAIMER

THE INFORMATION CONTAINED HEREIN HAS BEEN COMPILED BY SHORETEC® LLC AND TO THE BEST OF OUR KNOWLEDGE, ACCURATELY REPRESENTS THE SHORETEC® PRODUCT USE IN THE APPLICATIONS WHICH ARE ILLUSTRATED. FINAL DETERMINATION OF THE SUITABILITY FOR THE USE CONTEMPLATED AND ITS MANNER OF USE ARE THE SOLE RESPONSIBILITY OF THE USER. STRUCTURAL DESIGN AND ANALYSIS SHALL BE PERFORMED BY A QUALIFIED ENGINEER.

THIS DRAWING IS BEING FURNISHED FOR THIS SPECIFIC PROJECT ONLY. ANY PARTY ACCEPTING THIS DOCUMENT DOES SO IN CONFIDENCE AND AGREES THAT IT SHALL NOT BE DUPLICATED IN WHOLE OR IN PART, NOR DISCLOSED TO OTHERS WITHOUT THE CONSENT OF SHORETEC® L.L.C.